

DCR-200

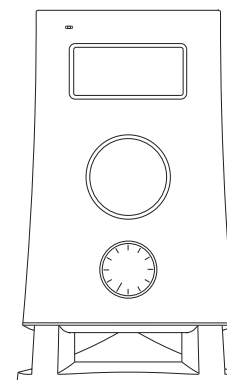

GB

Version 1



Table of Contents

<i>Important safety instructions</i>	2-3
<i>Introduction</i>	4
<i>Controls and connections</i>	5-8
<i>Display icons</i>	9
<i>Using the Digital Receiver for the First time</i>	10
<i>Operating Your Digital Receiver – DAB</i>	11-12
<i>Display Modes – DAB</i>	13-14
<i>Finding New Stations – DAB</i>	15
<i>Manual Tuning – DAB</i>	16
<i>Dynamic Range Control (DRC) settings – DAB</i>	17
<i>Operating your digital receiver – Search tuning FM</i>	18
<i>Manual tuning – FM</i>	19
<i>Display Modes – FM</i>	20
<i>FM Stereo / mono</i>	21
<i>Presetting Stations in DAB and FM modes</i>	22
<i>Recalling a Preset in DAB and FM modes</i>	23
<i>Clock and Alarms</i>	24-31
<i>Display and Audio</i>	32-36
<i>Information</i>	37-39

Important Safety Instructions

1. Read and understand all safety and operating instructions before the radio is operated.
2. Retain instruction: The safety and operating instructions should be retained for further reference.
3. Heed warnings. All warnings on the appliance and operating instructions should be followed.
4. Follow all operations and use instructions.
5. Water and moisture: The appliance should not be used near water. Do not use near a bathtub, washbowl, laundry tub, kitchen sink, wet basement, swimming pool, etc.
6. Unplug the radio from the AC power outlet before cleaning. Use only a damp cloth for cleaning the exterior of the radio.
7. Do not place the radio on an unstable cart, stand, bracket or table. The radio may fall, causing serious personal injury and damage to the radio.
8. Ventilation: This radio should be situated so that its location or position does not interfere with its proper ventilation. For example, the radio should not be used on a bed, sofa, rug or other soft surfaces that may block the ventilation openings. It should not be placed in a built-in situation like a cabinet that may reduce air flow through the ventilation openings.
9. Power sources: The radio should be operated only from the type of power source indicated on the marking label. If you are not sure of the type of power supply to your home, consult your radio dealer or power company.
10. Mains adaptor: The mains adaptor should be positioned so it is not walked on, pinched, or items placed on top of it. Pay particular attention to wires at plugs, convenience receptacles, and the point where they exit from the unit. Unplug the mains adaptor by gripping the adaptor, not the wire. Operate the radio using only the current type of power source indicated. If you are not sure of the type of power supply to your home, consult your dealer or local power company.
11. Do not overload wall outlets or extension cords. This can result in a risk of fire or electric shock. Never insert objects of any kind into the radio through opening. The objects may touch dangerous voltage points or short out parts. This could cause a fire or electric shock.
12. If the radio is left unattended or unused for long periods of time, unplug it from the wall outlet. This will prevent damage caused by lightning or power line surges.
13. If the radio is left unattended or unused for long periods of time, remove the batteries. The batteries may leak and damage furniture or your radio.

GB

- 
- 
14. Do not attempt to service the radio yourself. Removing the cover may expose you to dangerous voltage, and will void the warranty. Refer all servicing to authorized service personnel.
 15. Object and Liquid Entry-Never push objects of any kind into this radio through opening as they may touch dangerous voltage points or short-out parts that could result in a fire or electric shock. Never spill liquid of any kind of product.
 16. The appliance should be serviced by qualified personnel when:
 - A. The mains adaptor or the plug has been damaged.
 - B. Objects have fallen or liquid had been spilled into the radio.
 - C. The radio has been exposed to rain or water.
 - D. The radio does not appear to operate normally or exhibits a marked change in performance.
 - E. The radio has been dropped, or the enclosure damaged.



Introduction

The Sangean DCR-200 DAB/FM RDS Digital Receiver provides the following range of features in an stream-lined portable size:

- Ⓞ Radio for DAB and FM (with RDS) broadcasts.
- Ⓞ 20 radio station presets (10 for DAB and 10 for FM) and 8 my favorite stations (4 for DAB and 4 for FM).
- Ⓞ Clock display with time when in standby.
- Ⓞ Two alarm timers with snooze feature to wake you to either buzzer, radio alarm, voice messages.
- Ⓞ Adjustable sleep timer which can be set to turn the digital receiver off after between 15 and 120 minutes.
- Ⓞ 2 voice message recording function with each 10 seconds duration.
- Ⓞ A 3.5mm stereo Auxiliary Input socket for playing audio from MP3 players, iPod devices or other audio equipment.
- Ⓞ A standard 3.5mm headphone socket for private listening.
- Ⓞ Attractive, large and ergonomically designed knobs.
- Ⓞ Desirable and functional flat membrane push button.
- Ⓞ DC output socket for charging mobile phones, MP3 players or CD players.
- Ⓞ Built-in wire spring aerial and external FM/DAB wire spring aerial for radio reception.

GB

Controls and connections

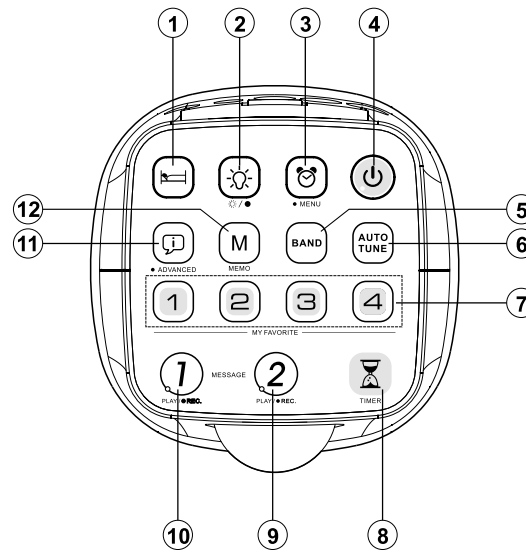

1. Sleep timer
2. Backlight
3. Alarm / Menu
4. Standby
5. Band
6. Auto Tune

7. Preset station 1 – 4
8. Timer
9. Message button
10. Message button
11. Advanced setting / Info button
12. Memory preset

Controls and connections

GB

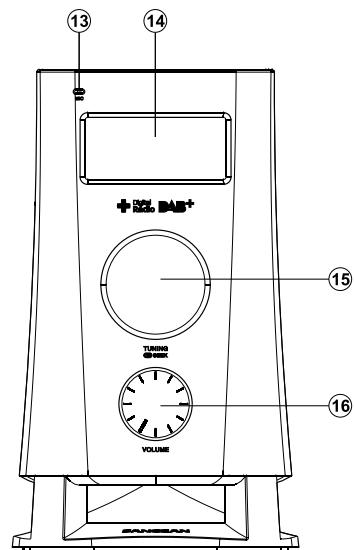

- 13. Microphone
- 14. LCD display

- 15. Tuning / Select knob
- 16. Volume knob

Controls and connections

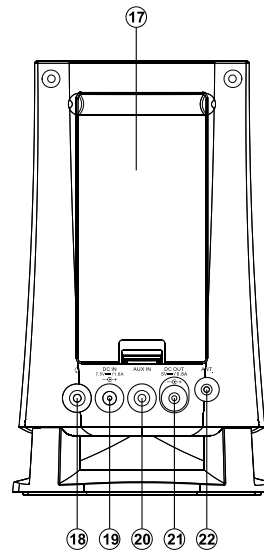

- 17. Battery compartment
- 18. Headphone socket
- 19. DC in jack

- 20. Aux in socket
- 21. DC out jack
- 22. Antenna socket

Controls and connections

GB

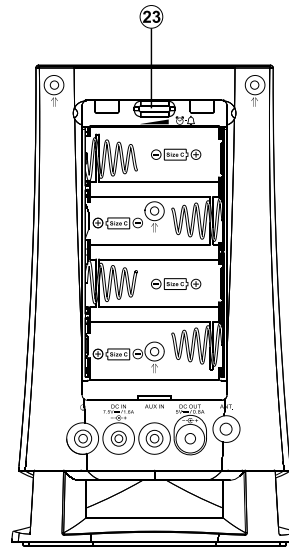

23. Buzzer volume adjuster

Display icons

- A. Battery capacity indicator
- B. Alarm 1 icon
- C. Alarm 2 icon
- D. DAB icon
- E. FM icon
- F. Timer icon
- G. Sleep timer / snooze indicator
- H. Signal strength indicator
- I. Time / Radio display screen

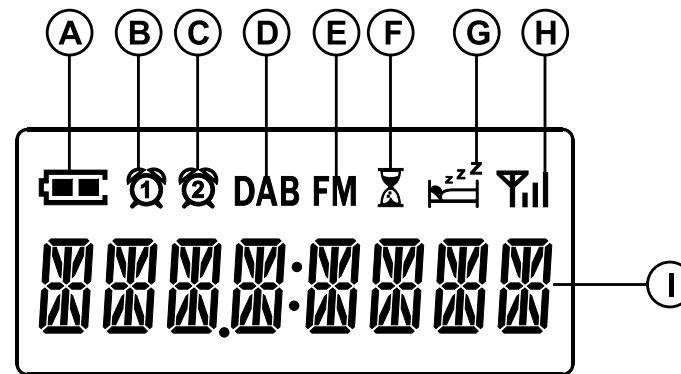

Using the digital receiver for the first time

GB

1. Place your digital receiver on a flat surface.
2. Insert the adaptor plug into the DC in socket located on the back of your digital receiver ensuring that the plug is pushed fully into the socket.
3. Plug the other end of the adaptor into the wall socket.

IMPORTANT:

The mains adaptor is used as the means of connecting the digital receiver to the mains supply. The mains socket used for the digital receiver must remain accessible during normal use. In order to disconnect the digital receiver from the mains completely, the adaptor should be removed from the mains socket outlet completely.

4. When your digital receiver is first switched on the clock display will show SANGEAN briefly first and then NO CLOCK, and the unit will enter standby mode. It will then scan for DAB radio stations and when stations have been found the clock time should be set automatically. Note that the display will not show any scanning message for this first scan.
5. If no stations have been found then the clock will not set. You may need to relocate your digital receiver to a position giving better reception. You should then carry out an auto-tune to find DAB stations.



SANGEAN

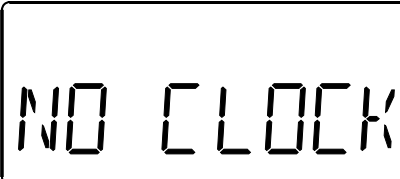

NO CLOCK

Operating your digital receiver – DAB

1. Press the Standby button to switch on the digital receiver.
If the digital receiver has been used before the last used mode will be selected.
2. Press and release the Band button as needed so that DAB mode is selected on the display.
3. If this is the first time the digital receiver is used a full scan of the DAB channels in your country will be carried out. The display will show "Tuning" for a few seconds. (If the digital receiver has been used before the last used station will be selected).
4. The first station in the list of stations found during the scanning process will be played. The display will show the station name.
5. If no signals are found, the digital receiver will show "OFF AIR" and it may be necessary to relocate your digital receiver to a position giving better reception, and then repeat the scan following above procedure.

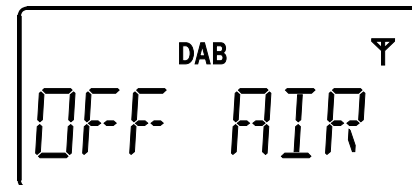
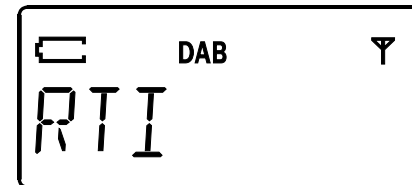
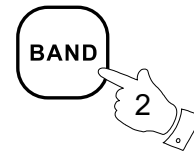
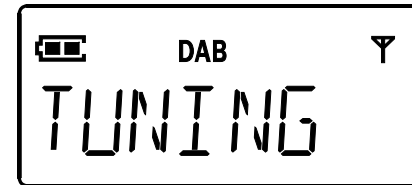
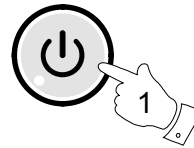

Selecting a DAB radio station

1. Press the Standby button to switch on your digital receiver.
The display will show "TUNING" for a few seconds.
2. Press the Band button to select DAB radio mode. The display normally shows the name of the current station selected.
3. Rotate the Tuning control to access the radio station list and to scroll through the list of available stations. Stop rotating the Tuning control when you find the station that you wish to hear.
4. Press and release the Tuning control to cause the digital receiver to tune to the chosen station. The display may show "TUNING" while your digital receiver finds the new station.
5. Adjust the Volume control to set the sound level as needed.

Secondary services

1. Certain radio stations have one or more secondary services associated with them. If a station has a secondary service associated with it then the secondary service will then appear immediately after the primary service as you rotate the Tuning control.
2. Most secondary services do not broadcast continually and if the selected service is not available, the radio will re-tune to the associated primary service.

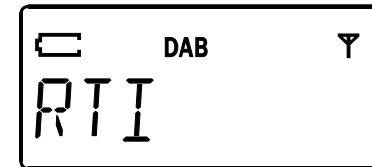
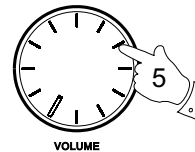
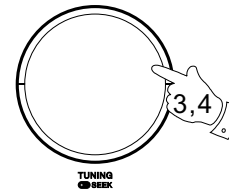
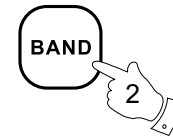
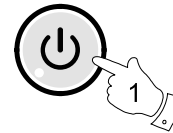

GB

Display modes – DAB

Your digital receiver has a range of display options when in DAB mode:

1. Repeatedly press and release the Info button to cycle through the different options.

- a. Station Name Displays the name of the station being listened to.
- b. Scrolling Text Displays scrolling text messages such as the artist or track name, phone in number, website address, etc.
- c. Program Type Displays the type of station being listened to such as Pop, Classic, News, etc.
- d. Multiplex Name Displays the name of the DAB multiplex to which the current station belongs.

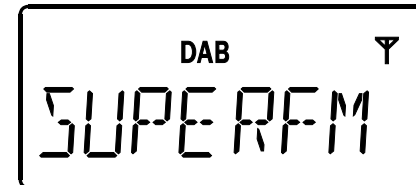
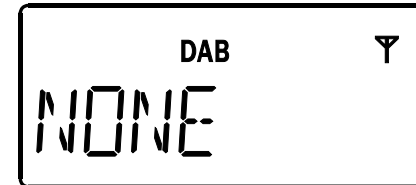
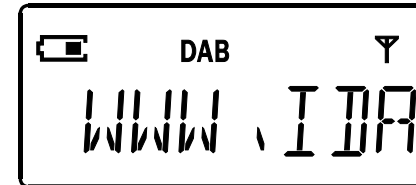
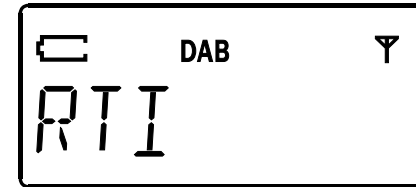

- e. Time Displays the current time.
- f. Date Displays the current date.
- g. Frequency & Channel Displays the frequency and channel number for the current DAB radio station.
- h. Bit Rate Displays the digital bit rate for the station being listened to.
- i. Signal Error Displays the bit error rate for the station being listened to.

The display will revert to a conventional time display 10 seconds after the last button pressed except when displaying scrolling text.

A signal strength indicator is always shown in the display on the upper right corner.

If the currently tuned station has been stored as a preset, then the preset number will also be shown.

GB

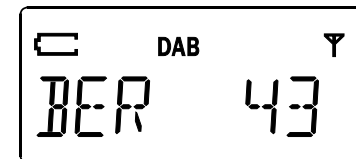
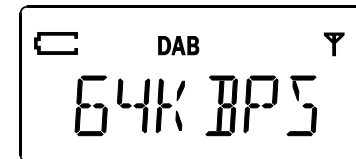
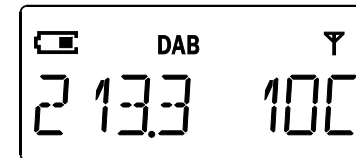
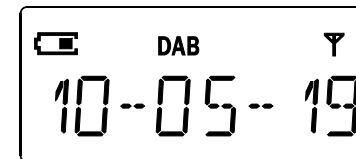
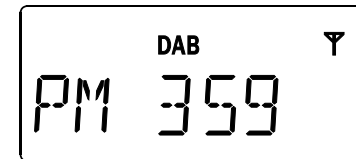

Finding new stations – DAB

Should you wish to use your digital receiver for DAB reception in a new location, or if no station were detected during the initial scan, you can follow this procedure to allow your digital receiver to find out which DAB radio stations are available.

1. With the unit in DAB mode press and release the Auto-tune button. The digital receiver will carry out a full scan of the entire DAB frequencies in your country.
2. As stations are found the station counter on the right-hand side of the display will show the total numbers of DAB stations in your area, and the stations will be added to the list.

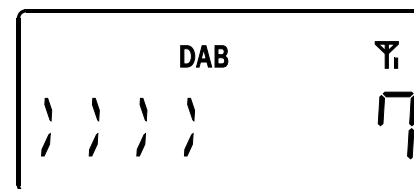
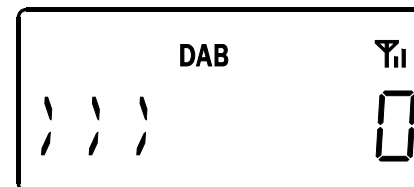
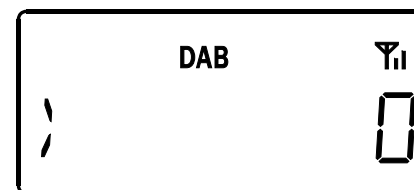
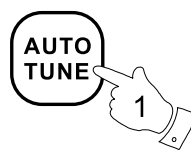

Manual Tuning - DAB

GB

Manual tuning allows you to tune directly to the various DAB Band III channels. DAB Band III channels are located in the range 5A to 13F.

1. Press and hold the Info button to enter Advanced Information so that the display shows "MANUAL".
2. Press and release the Tuning control to enter the Manual menu.
3. Rotate the Tuning control to select the required DAB channel.
4. Press and release the Tuning control to select the channel. If a signal is present, this will be indicated on a signal strength display. The minimum signal marker (0) shows the minimum signal strength needed for good DAB reception. The signal indicator chevrons go up or down showing the changing signal strength as you adjust the wire aerial or your digital receiver.
5. Any new stations that are found are automatically added to the stored list of stations.
6. Press and release the Tuning control to return to normal tuning mode.

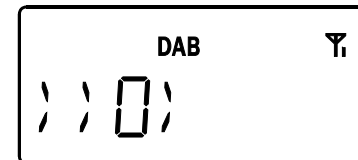
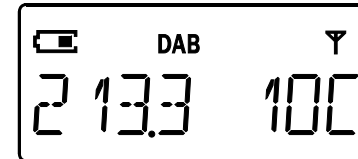
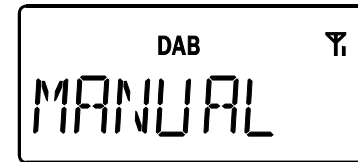
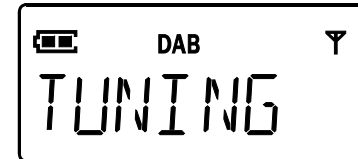
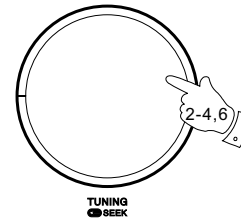

Dynamic Range Control (DRC) settings – DAB

Dynamic Range Control (also known as DRC) can make quieter sounds easier to hear when your radio is used in a noisy environment. This function is only for the DAB waveband.

1. Press the Standby button to switch on your digital receiver.
2. Press the Band button as needed to select the DAB radio mode.
3. Press and hold the Info button to enter the Advanced Information menu so that "MANUAL" appears on the display.
4. Rotate the Tuning control until the display shows "DRC VAL".
5. Press and release the Tuning control to enter the DRC adjustment mode.
6. Rotate the Tuning knob to select the required DRC setting (the default is 0).
DRC 0 DRC is switched off, Broadcast DRC will be ignored.
DRC 1/2 DRC level is set to 1/2 that sent by broadcaster.
DRC 1 DRC is set as sent by broadcaster.
7. Press and release the Tuning control to confirm the setting.
The display will then return to the previous radio display mode.

Note:

Not all DAB broadcasts are able to use the DRC function. If the broadcast does not support DRC, then the DRC setting in the radio will have no effect.

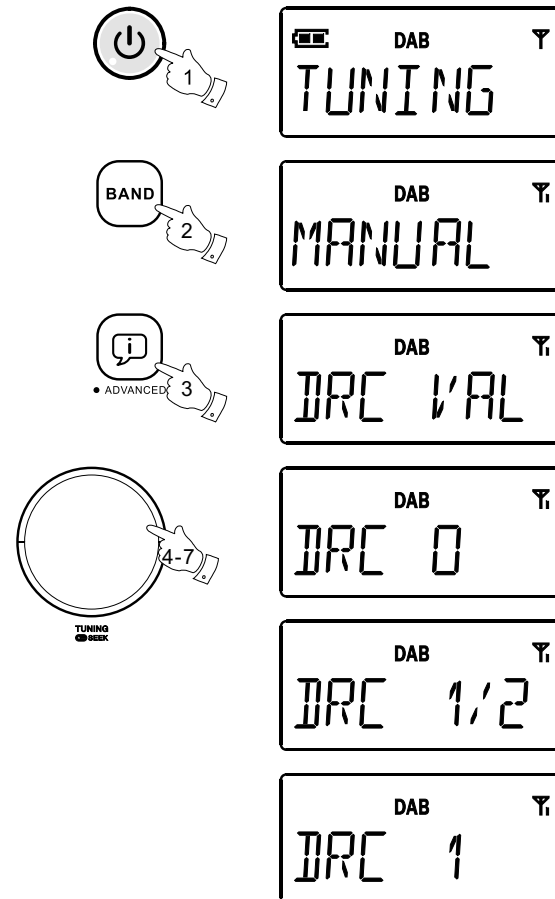

Operating your digital receiver – Search tuning FM

1. Press the Standby button to switch on your digital receiver.
2. Press the Band button as needed until the FM band is selected.
3. Press and release the Auto-tune button to carry out an auto-tune. Your digital receiver will scan up the FM band from the currently displayed frequency and will stop scanning automatically when it finds a station of sufficient strength. To scan down the FM band, press and hold the Auto-tune button.
4. The display will show the frequency of the signal found. If the signal is strong enough and there is RDS information available, soon after the display will show the radio station name.
5. To find more FM stations press and release the Auto-tune button to repeat the scan operation as DAB stations before.
6. When the end of the waveband is reached your digital receiver will recommence tuning from the opposite end of the waveband.
7. Use the Volume control to adjust the sound level as required.

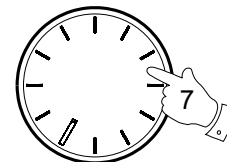
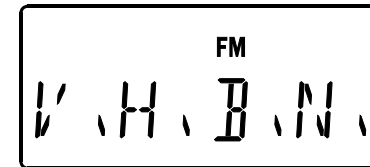
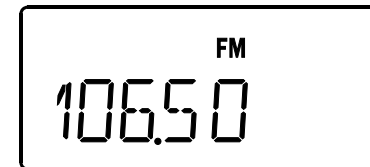
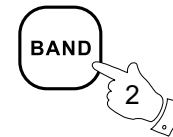
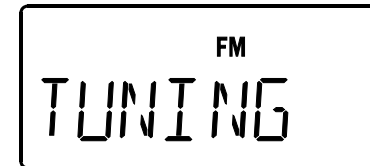
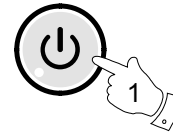

VOLUME

GB

Manual tuning – FM

1. Press the Standby button to switch on your digital receiver.
2. Press and release the Band button to select FM radio mode.
3. Rotate the Tuning control to tune to a station. The frequency will change in steps of 50kHz.
4. When the end of the end of the waveband is reached your digital receiver will recommence tuning from the opposite end of the waveband.
5. Use the Volume control to adjust the sound level as required.

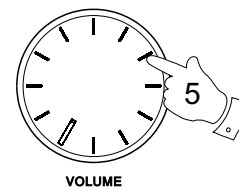
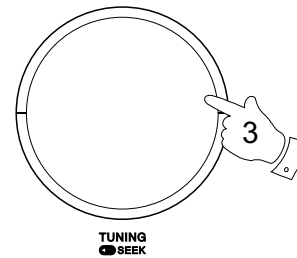
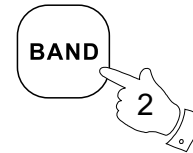
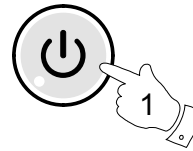

Display modes – FM

Your digital receiver has a range of display options for FM radio mode.

1. Repeatedly press and release the Info button to cycle through the different options.
 - a. Frequency Displays the frequency of the FM signal.
 - b. Station name Displays the name of the station being listened to.
 - c. Program type Displays the type of station being listened to such as Pop, Classic, News, etc.
 - d. Scrolling text Displays text messages such as new items etc.
 - e. Time Displays the current time.
 - f. Date Displays the current date.

Note:

If no RDS information is available, then the digital receiver will only be able to display the frequency. There will be no text or program type information available under these conditions.

The digital receiver only provides displays when there is information available. So if there is no text, for example, that display is not available.

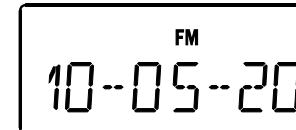
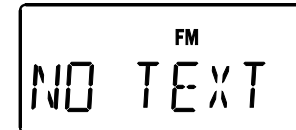
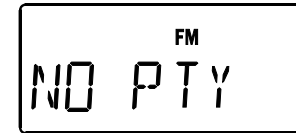
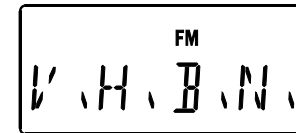
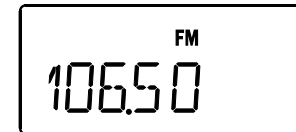

GB

FM stereo / mono

If the FM radio station being listened to has a weak signal some hiss may be audible. It is possible to reduce this hiss by forcing the radio to play the station in mono rather than stereo.

1. Press the Band button as needed to select the FM radio mode display and tune to the required FM station as previously described.
2. Press and release the Tuning control and if the display will show the current setting. If the setting is Auto press the Tuning control to switch to Mono mode to reduce the hiss.
3. To return to Auto (stereo) mode press and release the Tuning control again, so that the digital receiver will switch back to Auto mode.

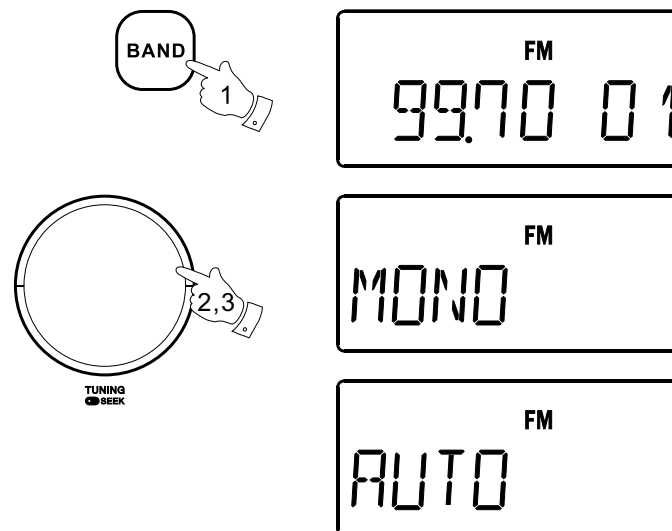

Presetting stations in DAB and FM modes

GB

There are 10 memory presets each for DAB and FM radio. Apart from the 10 presets, there are 4 my favorite stations. They are used in the same way for each waveband.

1. Press the Standby button to switch on your digital receiver.
2. Press the Band button to select the desired waveband. Tune to the required radio station as previously described.
3. Press and hold down the required favorite station number (1 to 4) until the display shows " * 1 saved". The station will be stored using the chosen number. Repeat this procedure for the remaining favorite stations as you wish.
4. To store the station in the 10 memory presets, press and hold the Memory button to enter the memory preset menu.
5. Rotate the Tuning control to select the required preset station number. Press and release the Tuning control until the display shows "06 SAVED".
6. Preset memories which have already been stored may be overwritten by following the above procedure if required.

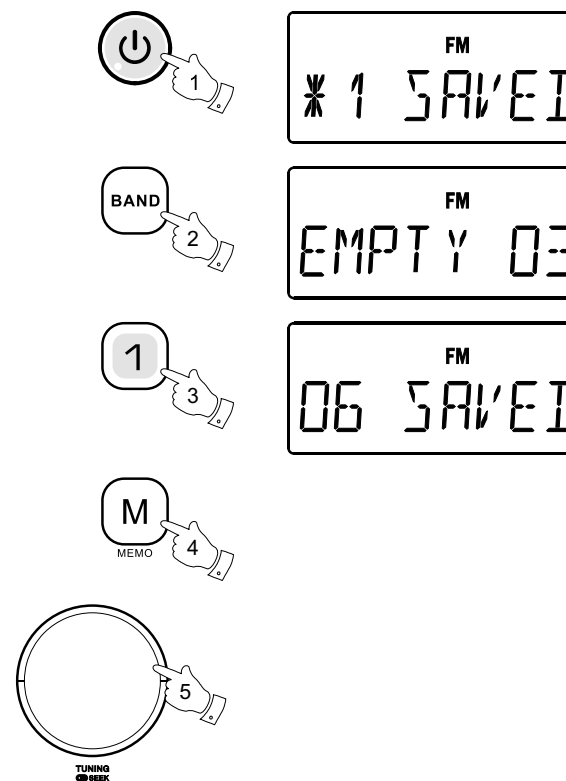

Recalling a preset in DAB and FM modes

1. Press the Standby button to switch on your digital receiver.
2. Select the required waveband by pressing the Band button.
3. To tune to one of the 4 my favorite stations stored in my favorite stations, press and release the my favorite station button.
4. Momentarily press the required main Preset button to cause your digital receiver to tune to one of the stations stored in the 10 main presets.
5. Rotate the Tuning control to scroll through the preset station list, and then press and release the Tuning control to select the desired preset station. Your digital receiver will tune to the chosen preset station stored in the preset memory.

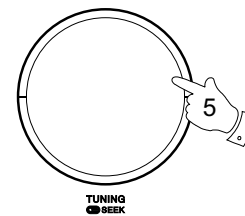
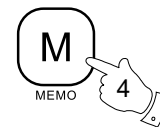
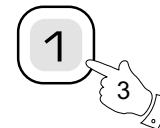
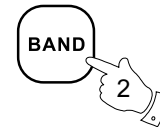
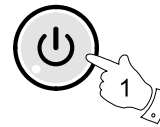

Clock and Alarms

GB

Automatically updating the clock

Your digital receiver will normally update the clock automatically when tuning to the radio broadcast. After a power failure the digital receiver will then set its clock the next time that you turn on the digital receiver in DAB or FM mode.

When the digital receiver is in Standby mode, the clock will be automatically synchronized with DAB radio.

Setting the time format

The clock display used in stand-by mode and on the playing mode screens can be set to 12 or 24 hour format. The selected format is then also used when setting the alarms.

1. With your digital receiver switched on, press and hold down the Menu button until the display shows "ALARM 1" flashing.
2. Rotate the Tuning control until "TIME FMT" shows on the display. Press the Tuning control to enter the system settings menu.
3. Rotate the Tuning control to select either 12 or 24 hour format. Press and release the Tuning control to confirm your choice of clock format. The display will then revert to the previous menu.

If the 12 hour clock format is chosen, the digital receiver will then use the 12 hour clock for the setting of alarms, and will display a 12 hour clock for the setting of alarms, and will display a 12 hour clock with an AM or PM indicator when in stand-by mode.

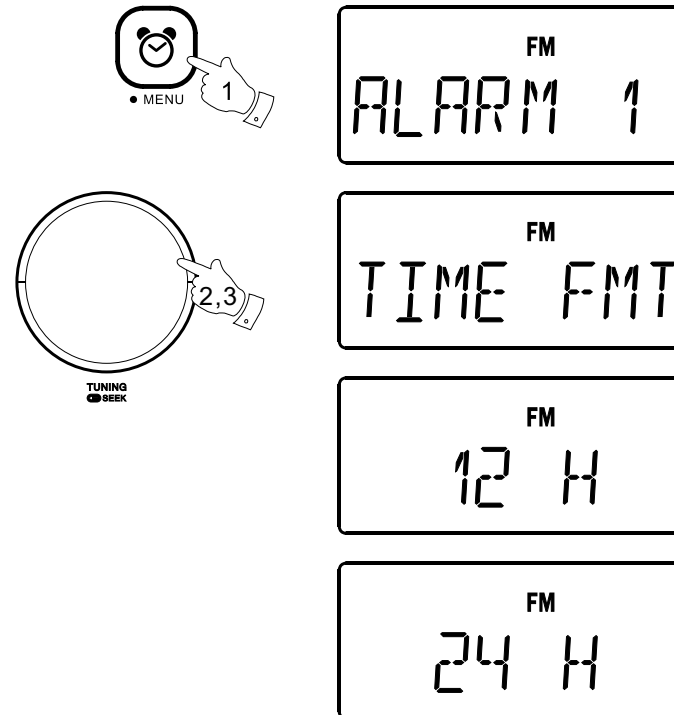

Setting the date format

1. With your digital receiver switched on, press and hold down the Menu button to access the menu setting.
2. Rotate the Tuning control until "DATE FMT" shows on the display. Press and release the Tuning control to enter the date format setting.
3. Rotate the Tuning control to select the required date format. Press and release the Tuning control to confirm your choice of date format. The display will then revert to the previous menu.

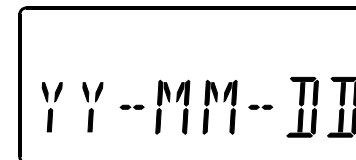
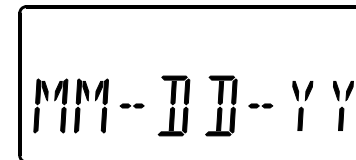
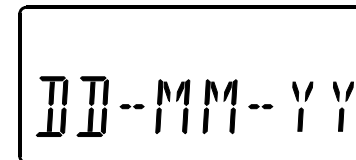
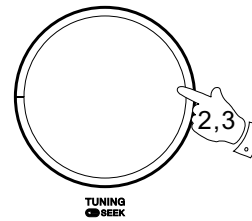
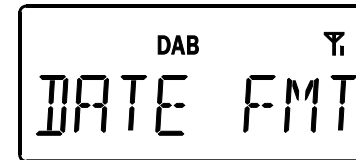

Setting the alarm clock

GB

Your DCR-200 digital receiver has two alarms which can each be set to wake you to DAB, FM radio, voice message or buzzer alarm. The alarms may be set while the unit is in standby mode or while playing. The alarm clock setting will not function when the display appears NO CLOCK.

1. Before setting an alarm ensure that the clock time is set. Press and hold the Alarm button. "Alarm 1" will show on the display.
2. Rotate the Tuning control to select the required alarm, 1 or 2. Press and release the Tuning control to enter the alarm setting.
3. Rotate the Tuning control to choose whether to set the alarm to On or Off. If you decide to abort alarm setting, choose Back and press the Tuning control.
4. Press and release the Tuning control. If the previous selection was to switch on the alarm, then alarm time setting will show on the display and the Alarm hour digits will flash. If Off was selected, the unit will exit the alarm menu.
5. Rotate the Tuning control to choose the alarm hour and then press and release the Tuning control to enter the hour setting. The alarm minute digits will then flash on the display.
6. Rotate the Tuning control to choose the alarm minute and then press and release the Tuning control to enter the minute setting.

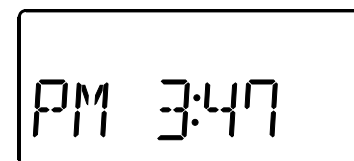
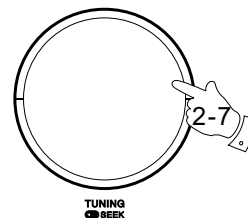
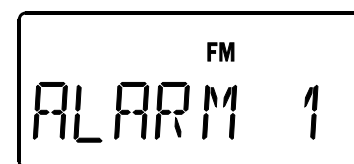

7. Rotate the Tuning control to choose the required alarm mode, and then press and release the Tuning control to confirm the setting. The alarm can be set to buzzer, DAB radio, FM radio, or voice message. When radio mode is selected, the radio alarm is set to the station most recently listened to.

BUZZER

DAB

FM

FM
MSG 1

FM
MSG 2

8. Rotate the Tuning control to select the required alarm frequency option when radio mode is selected. The display will show the frequency options for the alarm. The alarm options are as follows:
- OFF – the alarm will be disabled
 - ONCE – the alarm will sound once
 - DAILY – the alarm will sound everyday
 - WEEKDAYS – the alarm will sound on weekdays only
 - WEEKENDS – the alarm will sound only at weekends
- Press the Tuning control to confirm the setting.

9. The alarm has now been set. "SAVED" will show on the display, and then will revert to previous mode.

10. Rotate the Volume control to set the required volume. Adjust the switch inside the battery compartment to set the required volume level for buzzer alarm. When the digital receiver is set to wake by DAB, FM radio, or voice message, the alarm volume will be the volume previously listened to.

To view an alarm setting press and release the Alarm button and the display will show "Alarm 1". Press and release the Tuning control to enter the Alarm 1 setting, and repeatedly press and release the Tuning control to view through the alarm details.

Active alarms are shown using small alarm indicator at the top of the playing displays and on the clock display when in stand-by.

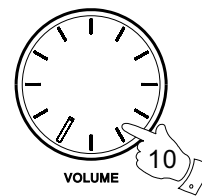

ONCE

DAILY

WEEK DAYS

WEEKENDS

SAVED

GB

When the alarm sounds

The alarm icon will flash at the display when an alarm is sounding. To cancel an alarm, press the Standby button to return to Stand-by mode.

When the buzzer alarm activates, the alarm will start softly and gradually increase in level. It will sound for 1 minute and silence for 1 minute at the selected time in repetition for up to 30 minutes unless cancelled. The digital receiver will sound at the selected time for up to 60 minutes for other alarm types.

Disabling alarms

1. To disable a single alarm enter the alarm setup menu and rotate the Tuning control until the desired alarm is shown on the display. Press the Tuning control.
2. Rotate the Tuning control until "OFF" is shown on the display, and press and release the Tuning control.
3. The display will return to previous mode and the chosen alarm will now be disabled.

Note: To cancel a sounding alarm, simply press the Standby button.

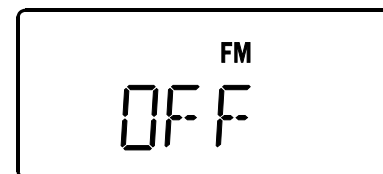
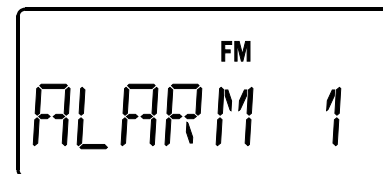
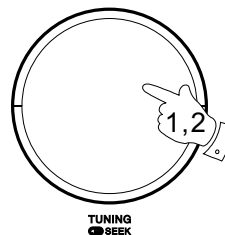

Snooze

1. When the alarm sounds, press any button other than the Standby button will silence the alarm for five minutes. The snooze symbol  will appear in the display.
2. To cancel the snooze timer while the alarm is suspended, press the Standby button.

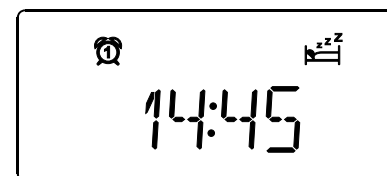

GB

Sleep timer

Your digital receiver can be set to turn off after a preset time has elapsed. The sleep timer setting can be adjusted between 15, 30, 60, 90 and 120 minutes.

1. To use the sleep timer, press and release the Sleep timer button to enter the sleep timer setting. "Sleep 15" will appear on the display.
2. Rotate the Tuning control to select the desired sleep time.
Your digital receiver will switch off after the preset sleep time has finished.
An active sleep timer is shown using a small sleep timer / snooze indicator at the top of the playing displays.
3. Use the OFF option to cancel the sleep function. To cancel the sleep function before the preset time has elapsed, either to set the sleep time to off or press the Standby button to turn the unit off manually.

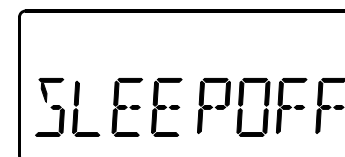
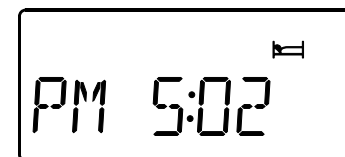
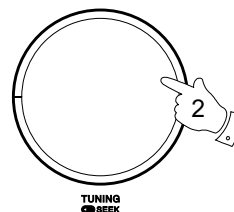
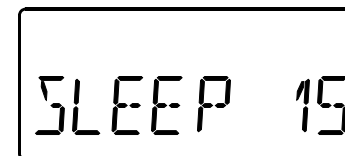
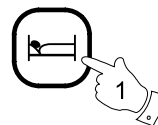

Egg timer function

1. Press and release the Egg timer button to enter timer setting and rotate the Tuning control to adjust the minute setting during 1 and 120 minutes with 1 minute interval.
2. Press and release the Tuning control to finish the setting and the egg timer will start to countdown, meanwhile the display will show the remaining minutes. The countdown display will become normal display after 10 seconds.
3. Press and release the Egg timer button to view the remaining time for an active timer setting. To cancel the function when countdown is progressing, press and hold the Egg timer button until the Egg timer indicator disappears.
4. Rotate the Tuning control while the display shows the remaining time of countdown to adjust the required timer setting again.

Note:

the digital receiver will sound for 3 minutes when an active timer finishes its countdown.

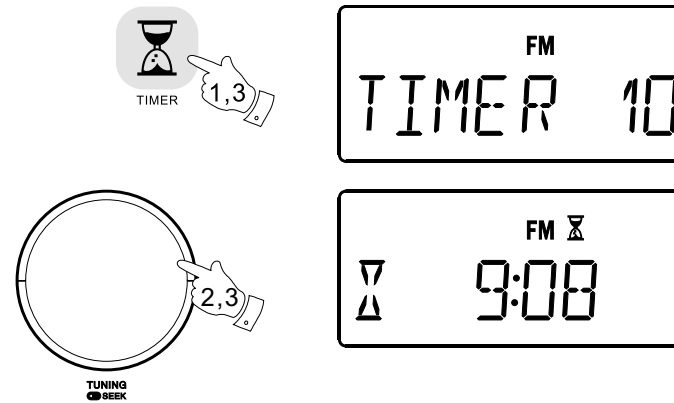

Display and Audio

GB

Brightness control

The brightness of the display when the unit is in standby mode may be adjusted. If you use the unit in the bedroom, you may prefer a lower standby brightness level than the standard setting.

1. Press the Backlight button so that the display shows for example "LIGHT 4".
2. Press the Backlight button one more time to change the standby brightness level. The backlight level will change at the same time so that you can see the effect of the change.

The default setting after a system reset is 3. Possible brightness values range from 1 – 7.

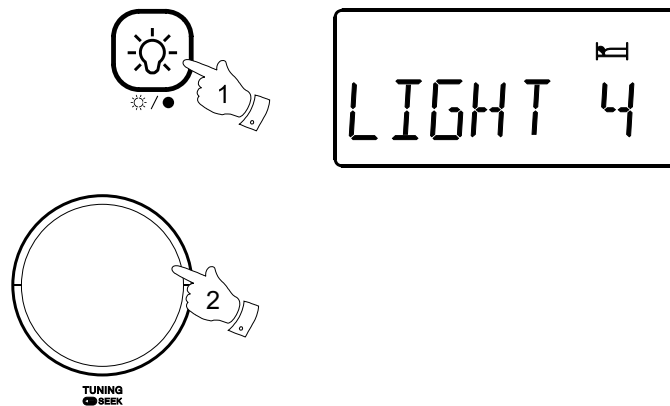

Moon LED

When using the digital receiver, you can turn on the moonlight LED at the bottom of the receiver for your better listening experience.

1. Press and hold the Menu button to enter the menu setting.
2. Rotate the Tuning control until the display show "MOON LED".
Press and release the Tuning control to enter the setting.
3. Rotate the Tuning control to select ON or OFF. Press and release the Tuning control again to confirm the setting.

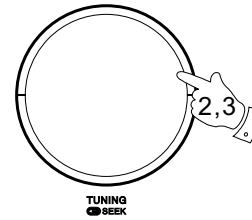

Message function

The message function can record and playback with 2 sets of voice message for 10 seconds each.

1. Press and hold the Message button to record the voice up to 10 seconds length. The LED is lighted during recording and the display will show RECORD. Press and release the Message button to pause the recording. After recording the LED will be flashing.
2. Press and release the Message button to playback the voice content, and the display will show PLAYING. Press the message button to pause the message while it is being playback, and the LED will dim.
3. To overwrite an existing message, press and hold the Message button for 2 seconds to start recording a new message.
4. This Message button can operate in power on or off mode. In power on mode the receiver even in DAB or FM as well as Aux-in will mute during the voice message processing.

Note:

The Message button LED will be lighted during recording and playing messages.

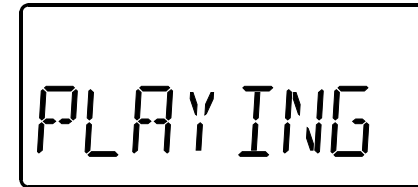

GB

Key tone adjustment

The sound of pressing the buttons of the receiver can be adjusted manually.

1. Press and hold the Menu button to enter the menu setting.
2. Rotate the Tuning control until the display shows "KEY TONE".
Press and release the Tuning control and select ON or OFF to activate or deactivate the key tone sound.

Note:

Setting of the buzzer volume adjuster on the rear of the unit may effect the key tone volume

Headphone socket

A 3.5mm stereo Headphone Socket is provided on the rear of your digital receiver for use with headphones. Inserting a plug automatically mutes the internal loudspeaker.

IMPORTANT:

Excessive sound pressure from earphones and headphones can cause hearing loss.

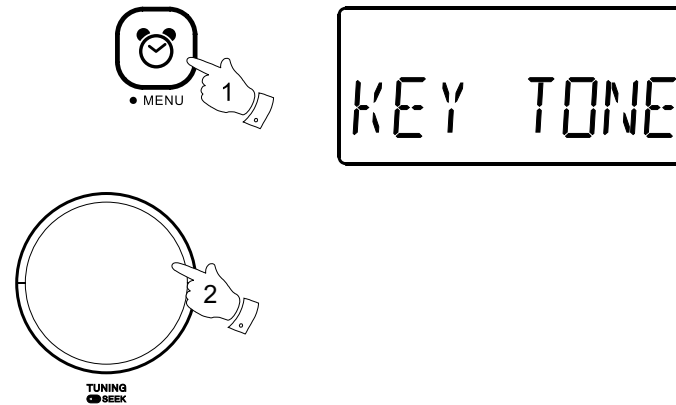

Auxiliary input socket

A 3.5mm stereo Auxiliary Input socket is provided on the rear of your digital receiver to permit an audio signal to be fed into the unit from an external audio device such as iPod, MP3 or CD player.

1. Repeatedly press and release the Band button until "AUX IN" is displayed.
2. Connect an external audio source (for example, iPod, MP3 or CD player) to the Auxiliary Input socket.
3. Adjust the volume setting on your iPod, MP3 or CD player to ensure an adequate signal level from the player, and then use the Volume control on the digital receiver as needed for comfortable listening.

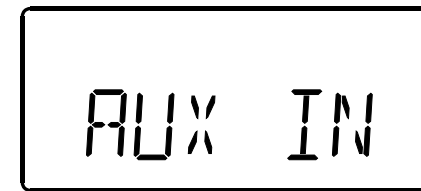
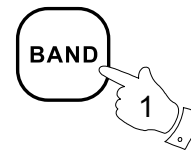

GB

DC out jack

A 4.4mm 5V / 0.8A DC output jack is provided along with the digital receiver for you to connect and charge any compatible external device. This function can only work in DC mode, and is not workable when using the batteries.

Information

System reset

If your radio fails to operate correctly, or some digits on the display are missing or incomplete carry out the following procedure.

1. Press and hold the Info button when the radio is in DAB or FM mode to enter Advanced Information.
2. Rotate the Tuning button until the display shows "FACTORY". Press and release the Tuning control so that the display shows "RESET".
3. Press and release the Tuning control again to confirm the reset operation. A full reset will be performed. The station list and presets will be set to empty. Alarms will be cancelled and Egg timer and sleep timer settings will be set to their default values. The display will show "NO CLOCK" and after a few seconds a station scan search will be performed automatically.

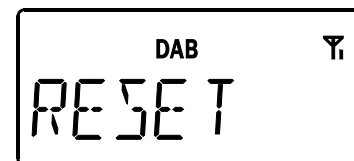
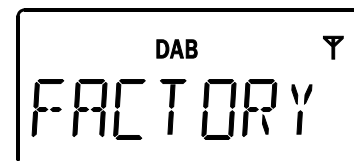
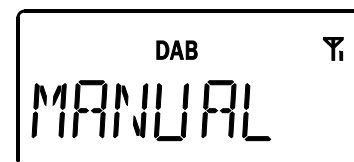
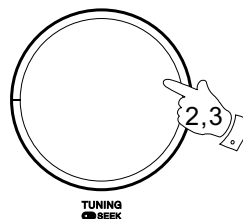

Software version display

1. Press and hold the Info button when the radio is in DAB or FM mode to enter the Advanced Information.
2. Rotate the Tuning control until the display shows "SW VER". Press the Tuning control again to show your digital receiver's software information.
3. After a few seconds your digital receiver will return to the normal radio display mode.

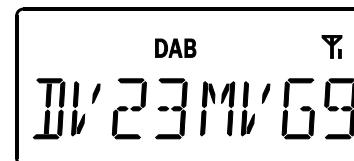
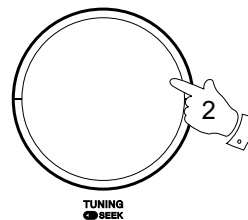
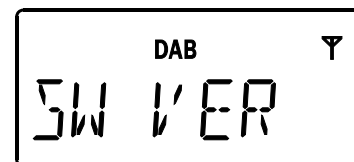

GB

Specifications

Power Requirements

Mains DC in 7.5V / 1.6A
DC out 5V / 0.8A

Frequency Range

FM: 87.5 – 108 MHz

Channel Block

DAB (BAND III) 5A – 13F

Battery

4 X 1.5V Size "C" / UM-2 / R14

Circuit Features

Loudspeaker	2.5"
Output Power	1 Watt
Headphone socket	3.5mm dia
Auxiliary socket	3.5mm dia
Aerial System	FM Wire aerial DAB Wire aerial



If at any time in the future you should need to dispose of this product please note that: Waste electrical products should not be disposed of with household waste. Please recycle where facilities exist. Check with your Local Authority or retailer for recycling advice. (Waste Electrical and Electronic Equipment Directive)